

REGISTRATION NUMBER

DVH0488

DATE OF REGISTRATION/PUBLICATION

9 28 2011
Month Day Year

DO NOT WRITE ABOVE THIS LINE. IF YOU NEED MORE SPACE, USE A SEPARATE CONTINUATION SHEET. (Form D-VH/CON)

1
TITLE

Please give the make and model of the vessel that embodies the design.

Sea Fox Bay Fox 240XT

2
DESIGN

(a) What is the type or style of the design for which registration is sought?
Center-console bay boat

(b) Provide a brief general statement setting forth the salient features of the design.
Hull form and shape;

Check here if this is a single design.

Deck configuration and layout; integrated planing pods in transom; reverse transom configuration; progressive downward strake design on hull

Check here if registering more than one design. Use Form D-VH/CON for additional designs.

(c) If this design is derived from an earlier design, describe how that design has been revised, adapted, or rearranged.

3
DESIGNER(S)

Provide the name and address of the designer(s). The name of the employer may be given instead of the designer(s) if, (1) the design was made within the regular scope of employment of the designer(s) and (2) the individual authorship of the design is difficult or impossible to ascribe.

Please check here if those conditions are satisfied and you are providing the employer's name.

Name: Sea Fox Boat Company, Inc.

Name:

Address: 2550 Hwy. 52

Address:

Moncks Corner, SC 29461

4
OWNER,
IF NOT
DESIGNER(S)

If the owner is different from the designer(s) or employer named above, provide the name and address of the owner:

Name:

Address:

5
PRIORITY
CLAIM

(a) Was an application for registration of this design identified in an application filed in a foreign country that extends to designs of owners who are citizens of the United States, or to persons filing applications in the United States, similar protection to that afforded in 17 USC chapter 13?

Yes No

(b) If yes, identify the country and date of application:
Country:

Date of application:

Serial No:

6
DATE MADE
PUBLIC

Was this design made public before the date of application? Yes No

If yes, on what date? January 1 2011
Month Day Year

DO NOT WRITE HERE
OFFICE USE ONLY

APPLICATION RECEIVED

9/28/2011

DESIGN COPIES RECEIVED

9/28/2011

FUNDS RECEIVED

EXAMINED BY JHA

FORM D-VH

CHECKED BY CCM

CORRESPONDENCE

Yes

FOR
COPYRIGHT
OFFICE
USE
ONLY

DO NOT WRITE ABOVE THIS LINE. IF YOU NEED MORE SPACE, USE A SEPARATE CONTINUATION SHEET. (Form D-VH/CON)

7

Please provide the name and address of the person to whom correspondence regarding this application may be directed:

CONTACT
PERSON

Name: David Cox, Esq.

Address: 5 Exchange Street

Charleston, SC 29401

Email address dcox@wcsr.com

FAX number 843-723-7398

Daytime phone: (843) 720-4665

8

Give the name and account number if the registration fee is to be charged to a deposit account established in the Copyright Office:

DEPOSIT
ACCOUNT

Name of Account: _____

Account number: _____

9

DECLARATION: The undersigned, as the applicant or the applicant's duly appointed agent or representative, being hereby warned that willful false statements are punishable by fine or imprisonment, or both, under 18 USC §1001, and that such willful false statements may jeopardize the validity of this application or any resulting registration, hereby declares to the best of his or her knowledge and belief:

CERTIFICATION AND
SWORN STATEMENTS

- (1) that the design has been fixed in a useful article;
- (2) that the design is original and was created by the designer(s), or employer if applicable, named in the application;
- (3) that those aspects of the design for which registration is sought are not protected by a design patent;
- (4) that the design has not previously been registered on behalf of the applicant or applicant's predecessor in title; and
- (5) that the applicant is the person entitled to protection and to registration under chapter 13 of title 17, *United States Code*.

Complete if applicable:

The design has been made public with a design notice as prescribed by 17 USC §1306.
Following is the exact form of the design notice:

Where on the useful article is the design notice located?

If the undersigned is not the applicant, he or she is properly authorized to execute this application on behalf of the applicant.

Ryan Balderson

Print or type name

843-761-6090

Telephone number

Fax number

Date

9/20/2011

VP of Product Development

Position or title

rbalderson@seafoxbboats.com

Email address

Copyright Office fees are subject to change. For current fees, check the Copyright Office website at www.copyright.gov, write the Copyright Office, or call (202) 707-3000.

Certificate
will be
mailed in
window
envelope
to this
address:

Name ▼

David Cox, Esq.

Number/Street/Apt ▼

5 Exchange Street

City/State/Zip ▼

Charleston, SC 29401

YOU MUST:

- Complete all necessary spaces
- Sign your application in space 9

**SEND ALL 3 ELEMENTS
IN THE SAME PACKAGE:**

1. Application form
2. Nonrefundable filing fee in check or money order payable to Register of Copyrights
3. Design material

MAIL TO:

Dept. D-VH
Vessel Hull Registration
PO Box 71380
Washington, DC 20024-1380

17 USC §1327. Penalty for false representation. "Whoever knowingly makes a false representation materially affecting the rights obtainable under this chapter for the purpose of obtaining registration of a design under this chapter shall pay a penalty of not less than \$500 and not more than \$1,000, and any rights or privileges that individual may have in the design under this chapter shall be forfeited."

Seafox 240xt Bay Fish

Fig 1

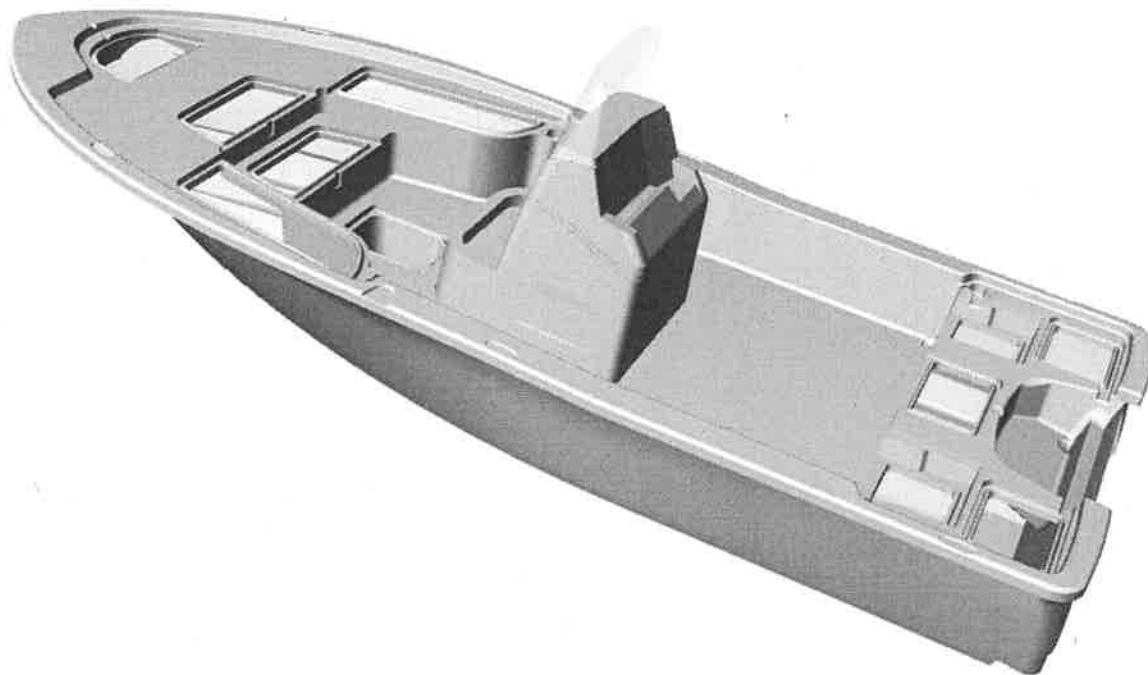

Seafox 240xt Bay Fish

Fig 2

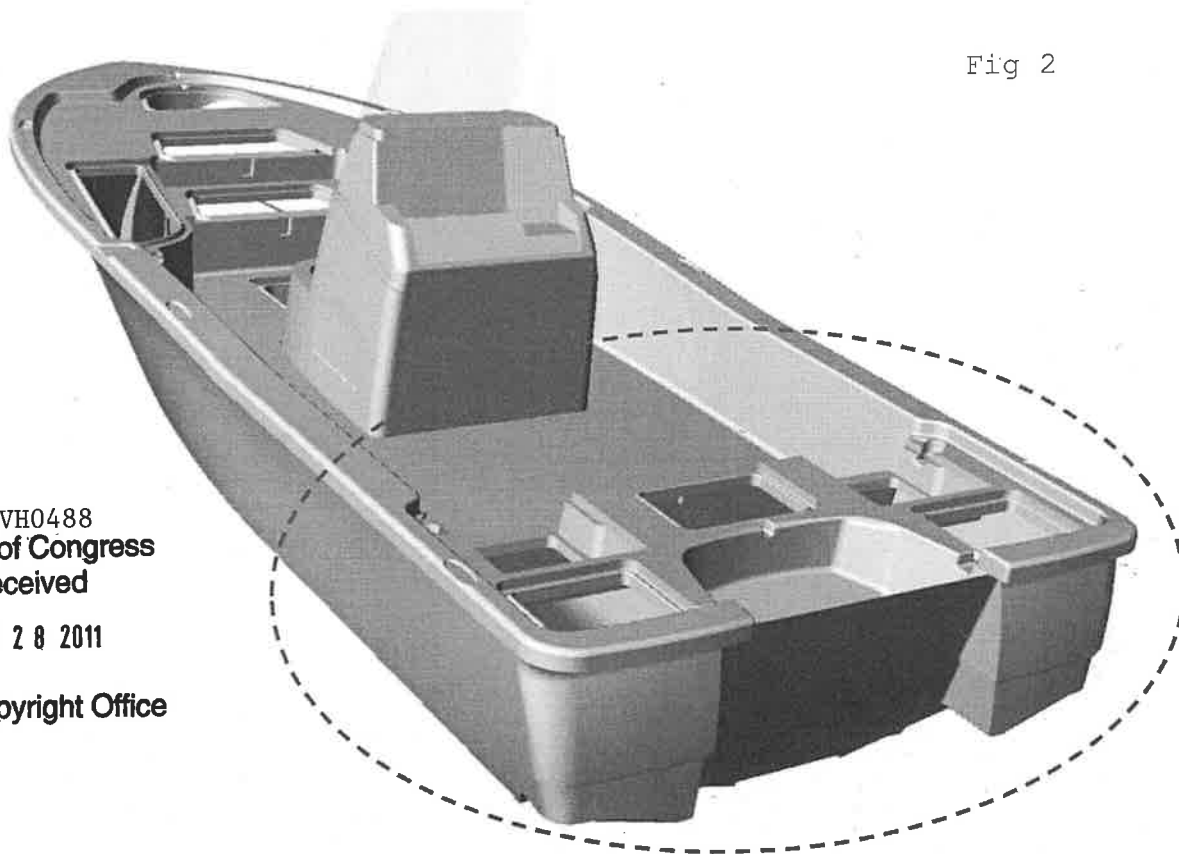

DVH0488
Library of Congress
Received

SEP 28 2011

U.S. Copyright Office

Seafox 240xt Bay Fish

Fig 3

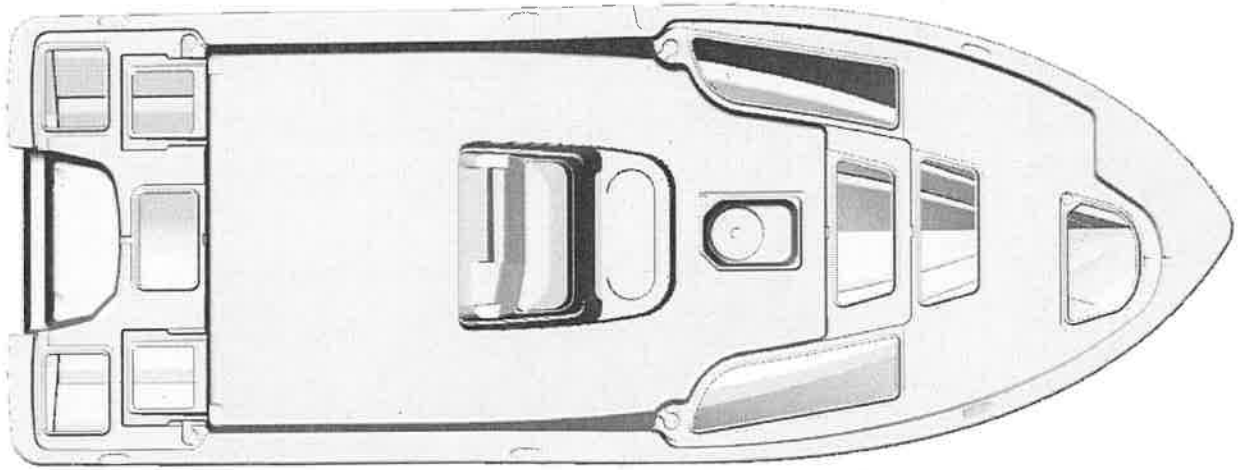

Seafox 240xt Bay Fish

Fig 4

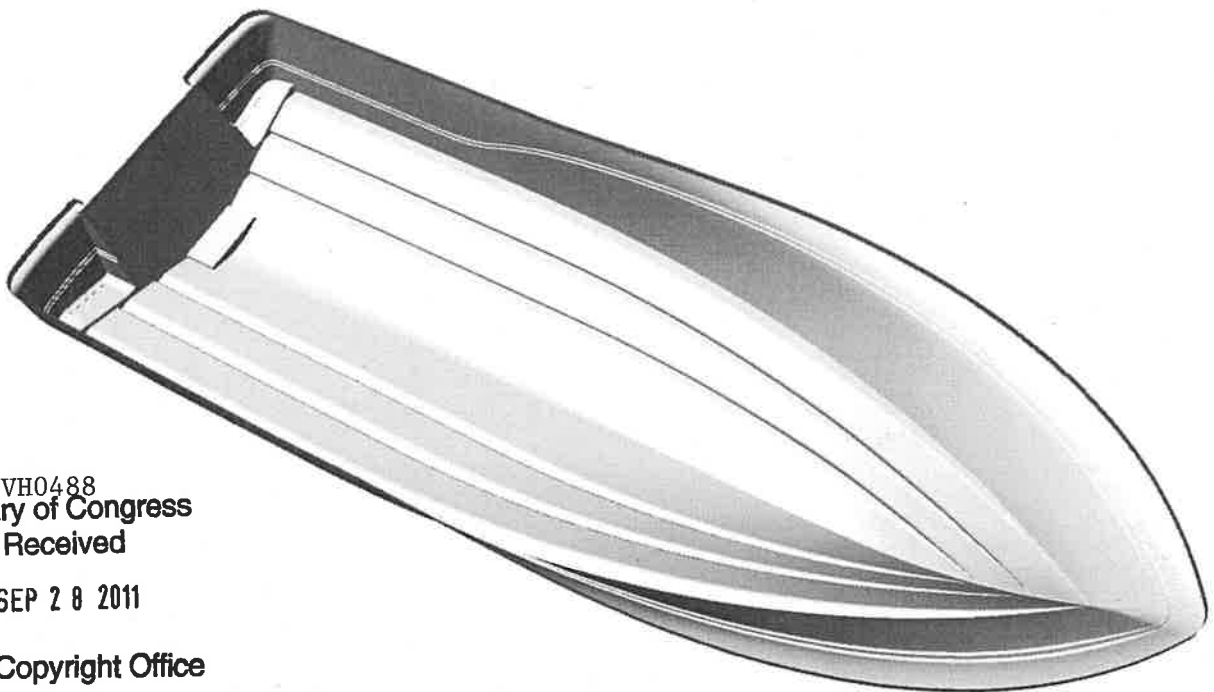

DVH0488
Library of Congress
Received
SEP 28 2011
U.S. Copyright Office

Seafox 240xt Bay Fish

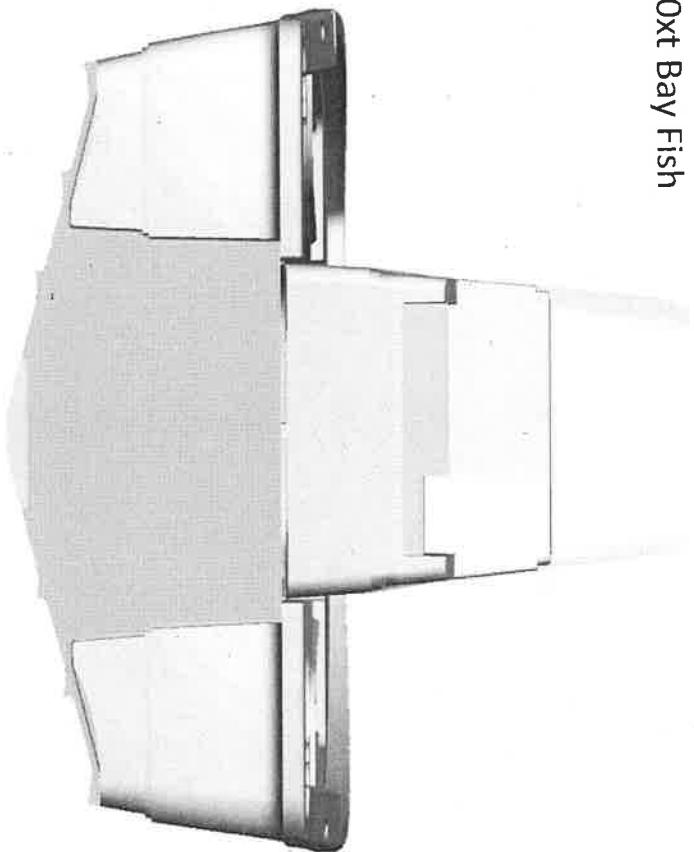

Fig 5

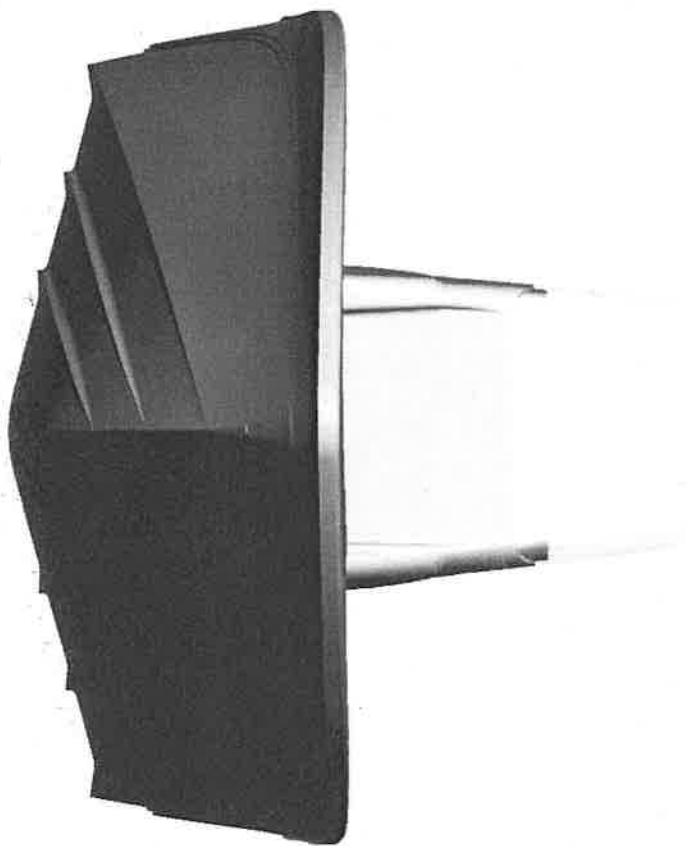
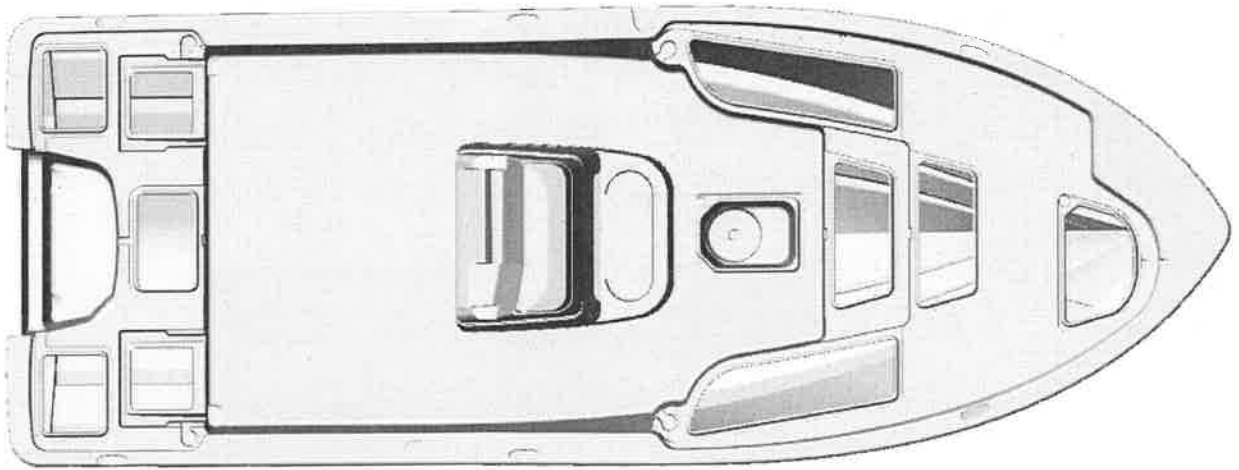

Fig 6

DVH0488
Library of Congress
Received
SEP 28 2011
U.S. Copyright Office

Seafox 240xt Bay Fish

Fig 7



Seafox 240xt Bay Fish

Fig 8

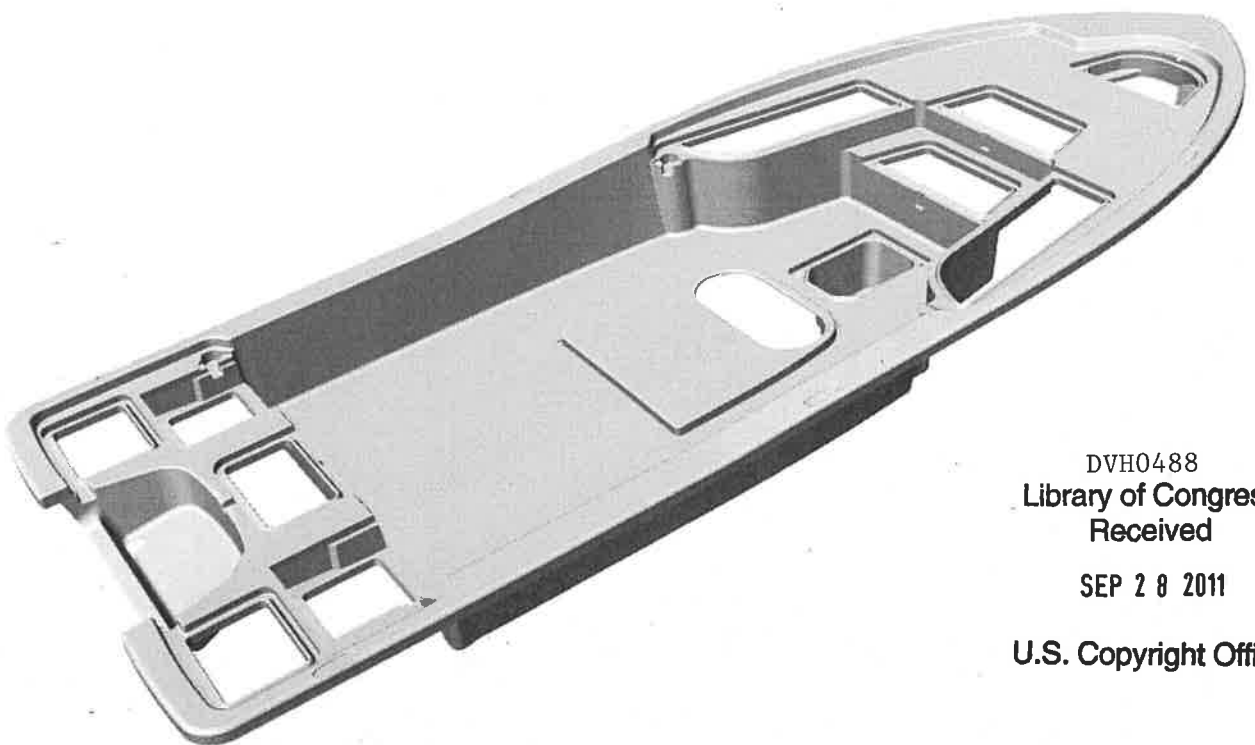

DVH0488
Library of Congress
Received

SEP 28 2011

U.S. Copyright Office

Seafox 240xt Bay Fish

Fig 9

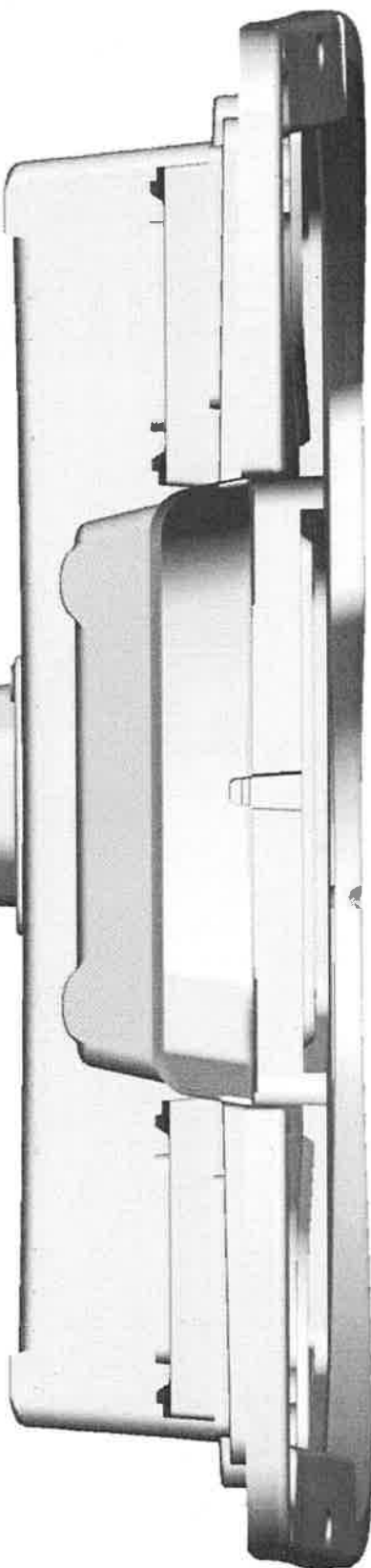
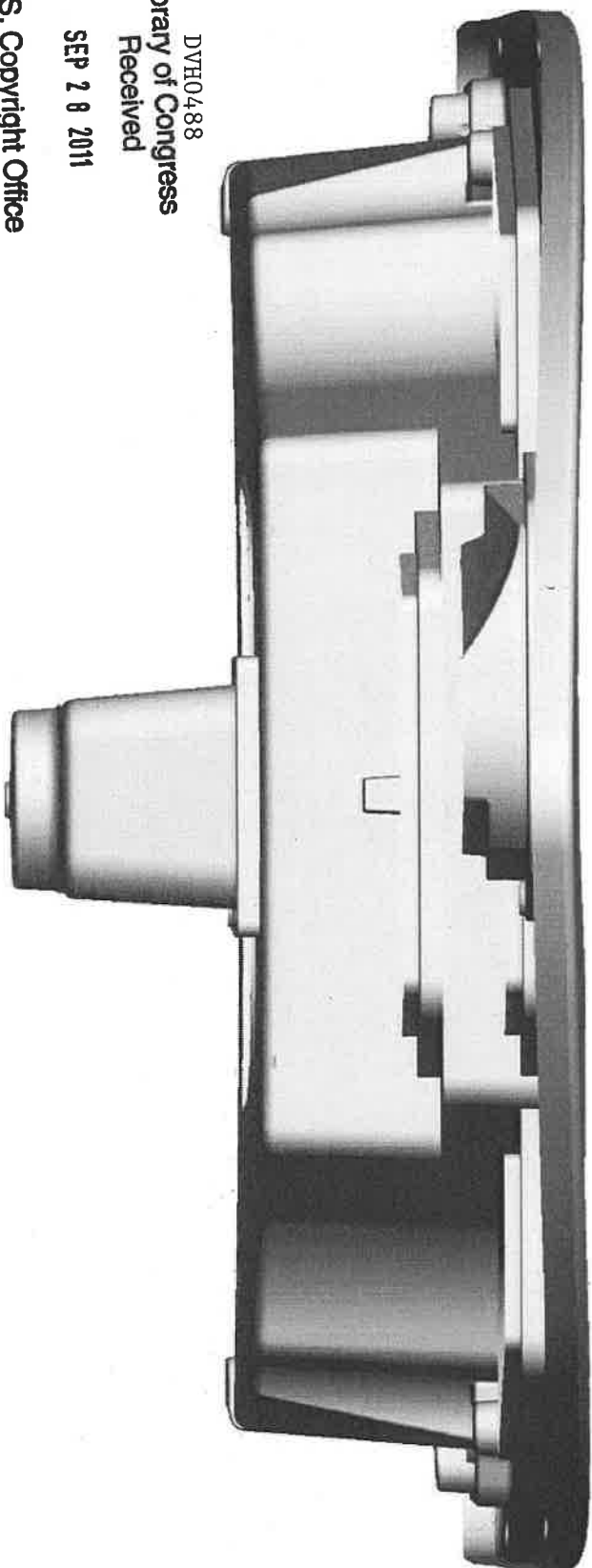

Fig 10



DVH0488
Library of Congress
Received

SEP 28 2011

U.S. Copyright Office

Seafox 240xt Bay Fish



Fig 11



Fig 12

DVH0488
Library of Congress
Received

SEP 28 2011

U.S. Copyright Office

Seafox 240xt Bay Fish

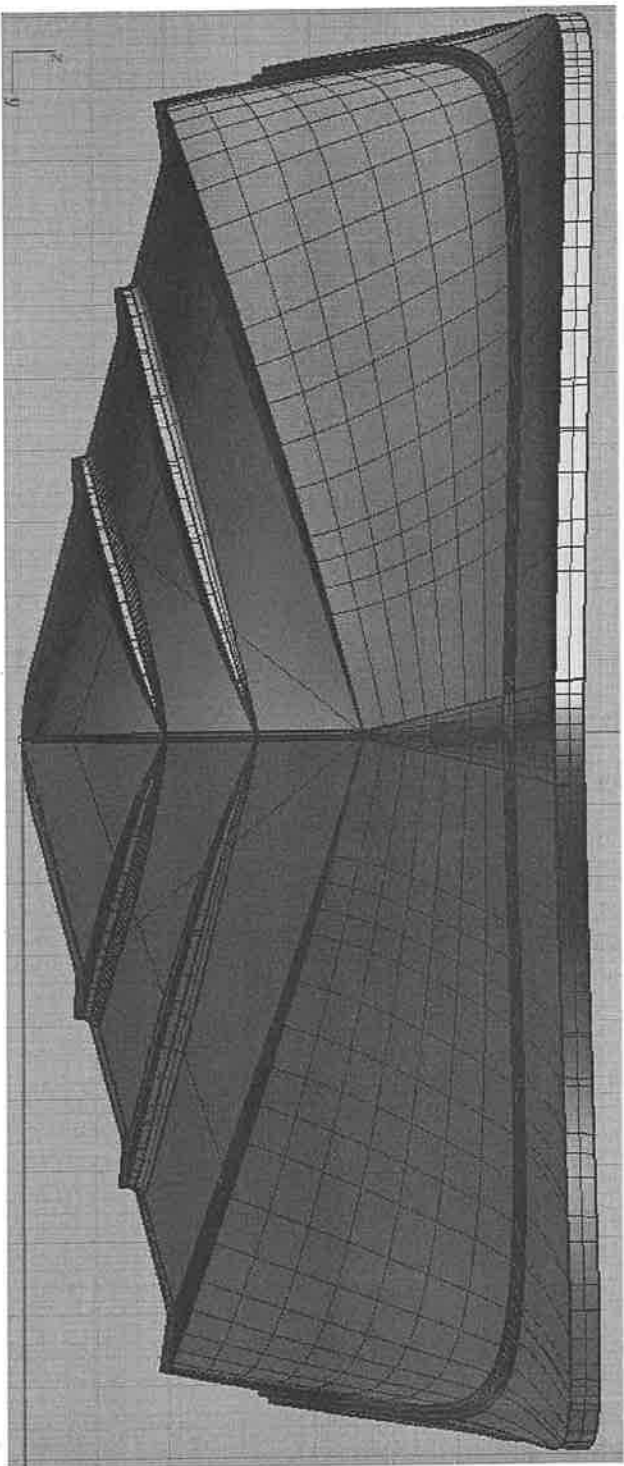

Fig 13

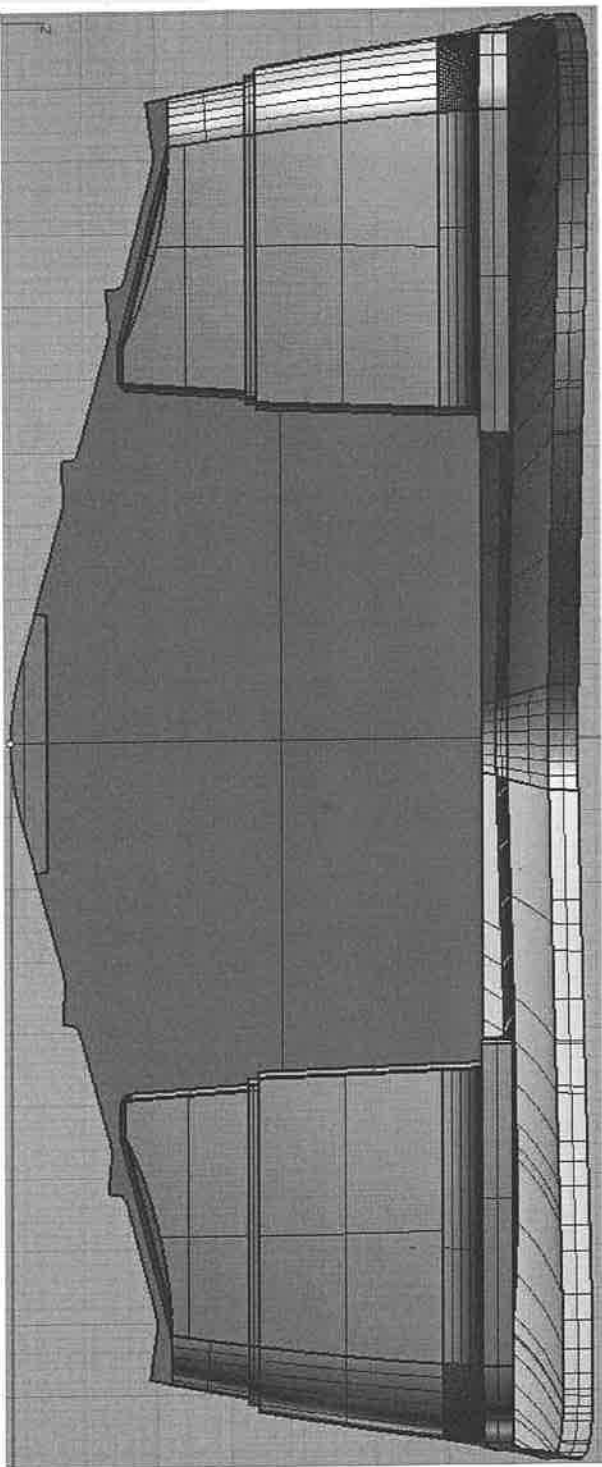

Fig 14

DVH0488
Library of Congress
Received

SEP 2 8 2011

U.S. Copyright Office

DVH0488

Library of Congress
Received

SEP 2 8 2011

U.S. Copyright Office

Seafox 240xt Bay Fish

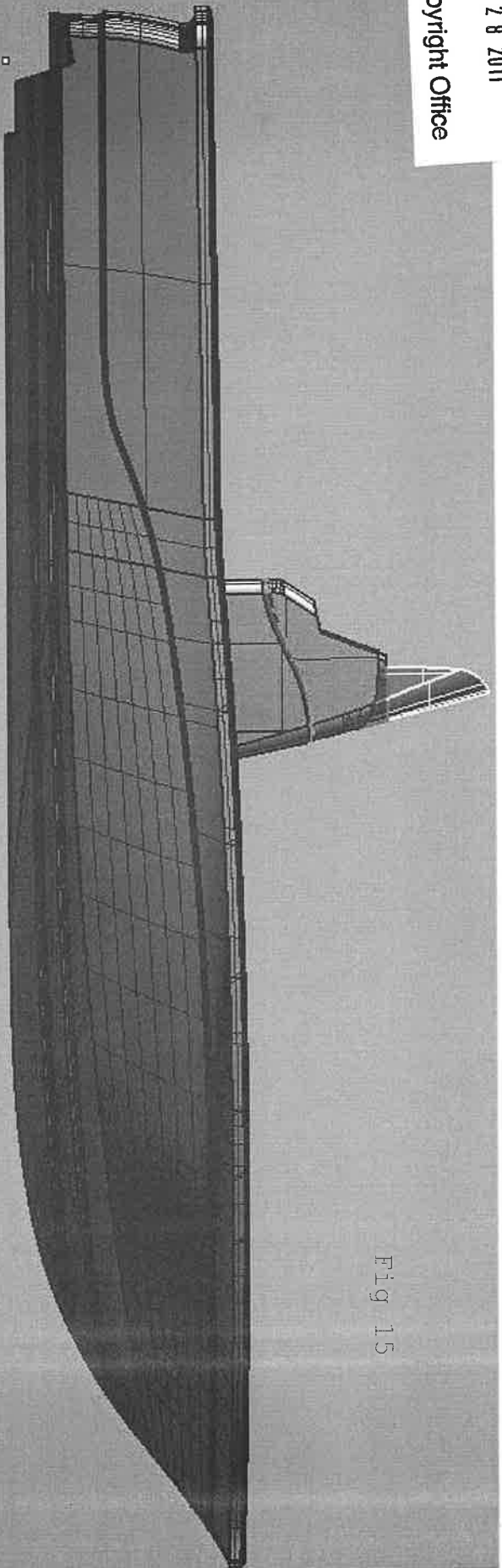

Fig 15

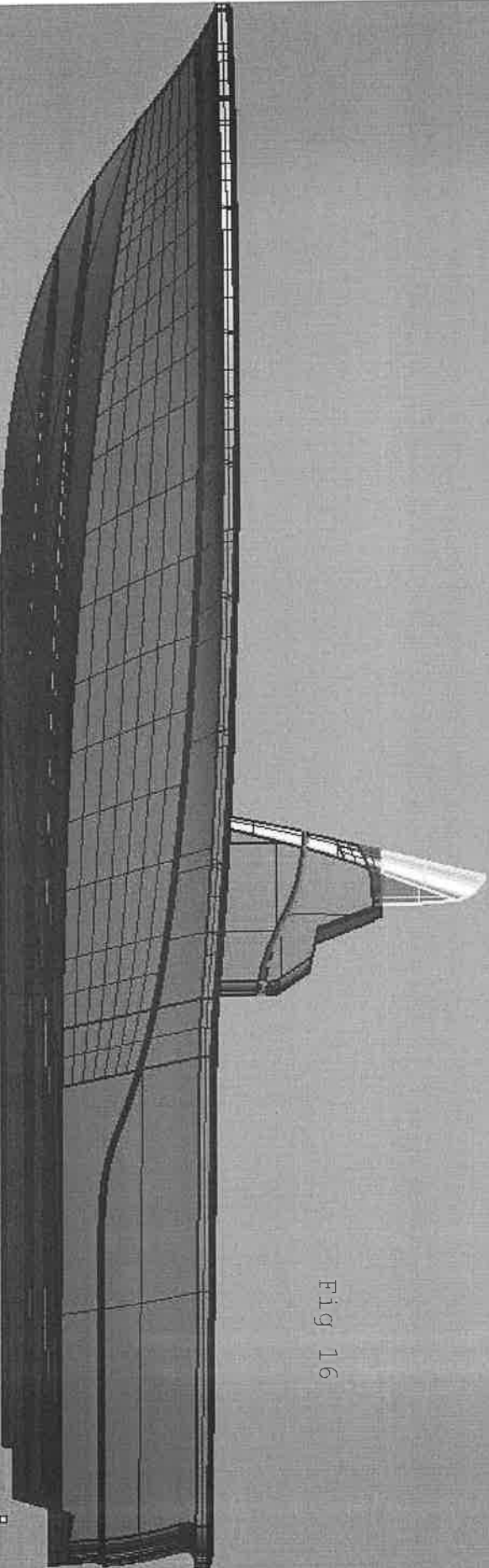

Fig 16

Seafox 240xt Bay Fish

DVH0488

Library of Congress
Received

SEP 28 2011

U.S. Copyright Office

Fig 17

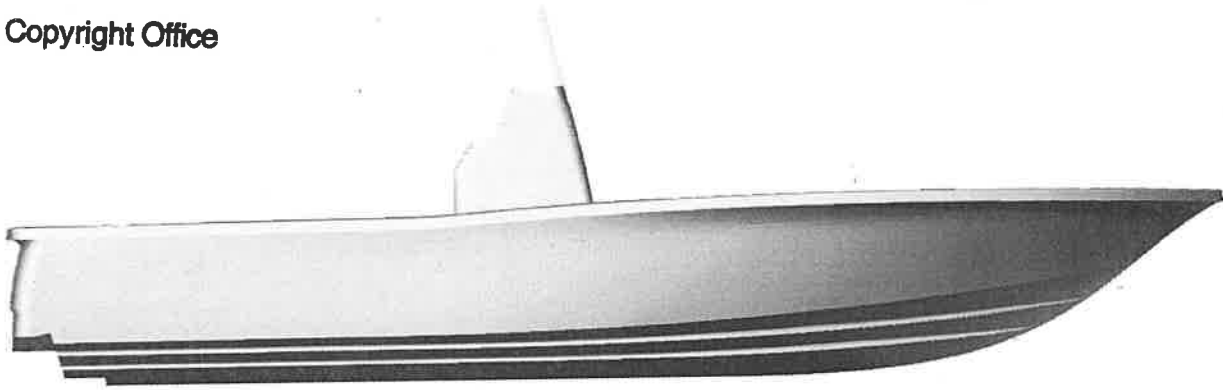

Seafox 240xt Bay Fish

Fig 18

